



Pump House, Unit 12 Bilton Road Industrial Estate, Erith, Kent DA8 2AN  
Tel: 01322 357080 Fax: 01322 341341  
E-mail: sales@pts-jung.co.uk WWW: www.pts-jung.co.uk

## LEVEL ALARM SYSTEM (PTS.SA1) MAINS-POWERED WITH BATTERY BACK-UP



### FEATURES:

- Electronic alarm;
- Power 1~ 50/ 60Hz 230V + / - 10%
- N° 1 inlet in low tension for alarm control from free contact;
- N° 1 inlet in low tension for alarm control from free contact N.C.
- Green led "Power on"
- Red led "Alarm"
- Red led "Siren Excluded"
- N° 1 but ton "TEST" for temporary sounder activation
- N° 1 but ton "RESET" for manual restore of alarm condition
- N° 1 but ton "SIREN ACTIVATION" for the activation of the sounder
- N° 1 but ton "SIREN EXCLUSION" to exclude the sounder
- Internal selector to select alarm restore (automatic – manual )
- Internal selector to activate the timer of automatic switch off of the alarm
- Trimmer to select the time of delay of automatic switch off (from 25" to 120")
- Fuses of protection supplied and battery
- Output with cable holder
- Alarm sounder 90 dB 12Vcc
- Internal sealed battery 12Vcc 1,2Ah
- Alarm output in free contact terminal board 250V~ 10A
- Flashing red lamp alarm 3W 12Vcc (only in model SLA1)
- Box in thermoplastic material - Protection IP55
- Dimensions 24x15x32cms(WxDxH)
- PTS is an approved Fourgroup Dealer

# INDEX

1. **Warnings**  
Page.....3
2. **Overview**  
Page.....4
3. **Handling**  
Page.....4
4. **Application and working limits**  
Page.....5
5. **Operation**  
Page.....6
6. **Installation**  
Page.....7
7. **Electrical connection**  
Page.....8
8. **Regulation and calibration**  
Page.....9
9. **Lights**  
Page.....10
10. **Maintenance**  
Page.....10
11. **Waste disposal**  
Page.....10
12. **Warranty**  
Page.....11
13. **Spare parts**  
Page.....11
14. **Conformity declaration**  
Page.....12

# 1. WARNINGS

The following symbols, accompanied by the words: "Danger", "Warning", indicate the potential hazard resulting from failure to observe the associated warning, as specified below:



**DANGER**  
**RISK OF ELECTRIC**  
**SHOCK**

Failure to observe this warning may result in electric shock



**DANGER**

Failure to observe this warning may cause personal injury and/or damage to property



**WARNING**

Failure to observe this warning may cause damage to the pump, the unit or the system

- **CAUTION:**  
Make sure the pumps are fully primed before you start them.
- **CAUTION:**  
The control panel must be connected by a qualified electrician in compliance with the electrical regulations in force.
- **CAUTION:**  
The electric pump or the motor and the panel must be connected to an efficient grounding system in compliance with the electrical regulations locally in force.
- **CAUTION:**  
Ground the unit before carrying out any other operation.
- **CAUTION:**  
The electric pump or the motor can start up automatically.
- **CAUTION:**  
As a general rule, always disconnect the power supply before proceeding to carry out any operation on the electrical or mechanical components of the unit or system.

## 2. OVERVIEW

The purpose of this manual is to provide the necessary information for the proper installation, use and maintenance of ALARM. The user should read this manual before operating the unit. Improper use may cause damage to the machine and lead to the forfeiture of the warranty coverage. Always specify the model identification code and the construction number when requesting technical information or spare parts from our Sales and Service department. The instruction and warnings given below concern the standard version; refer to the sale contract documentation for modifications and special version characteristics. For instructions, situations and events not considered in this manual or in the sale documents, please contact our customer service.

Our units must be installed in sheltered, well-ventilated, non-hazardous environments and must be used at a maximum temperature of +40°C and minimum of +4°C.

## 3. HANDLING



**DANGER**



**WARNING**

The panel must be handled with care, as falls and knocks can cause damage without any visible external signs.

If for any reason the unit is not installed and starter immediately after it has reached its destination it must be stored properly. The external packaging and the separately packed accessories must remain intact, and the whole must be protected from the weather, especially from freezing temperatures, and from any knocks or falls.

**PRELIMINARY INSPECTION:** after you have removed the external packaging, visually inspect the control panel to make sure it has suffered no damage during shipping.

If any damage is visible, inform a MWR Italia dealer as soon as possible, no later than 5 days from the delivery date.

## 4. APPLICATION AND WORKING LIMITS



**DANGER  
RISK OF ELECTRIC  
SHOCK**



**WARNING**

ALARM is suitable for the visual and acoustic signalling, in fire-fighting systems or in any system where it is required an alarm even in case of power loss from the NET.

**FOURGROUP S.r.l. shall not be liable for any damage caused or suffered by the unit as a result of its unauthorised or improper use.**

TECHNICAL FEATURES :

- Electronic alarm;
- Alimentazione 1~50/60Hz 230V +/- 10%
- N°1 inlet in low tension for alarm control from free contact ;
- N°1 inlet in low tension for alarm control from free contact N.C. ;
- Green led " Power on ";
- Red led "Alarm";
- Red led " Siren Excluded ";
- N° 1 button " TEST " for temporary sounder activation ;
- N° 1 button " RESET " for manual restore of alarm condition ;
- N° 1 button " SIREN ACTIVATION " for the activation of the sounder ;
- N° 1 button "SIREN EXCLUSION" to exclude the sounder ;
- Internal selector to select alarm restore ( automatic – manual ) ;
- Internal selector to activate the timer of automatic switch off of the alarm ;
- Trimmer to select the time of delay of automatic switch off ( from 25" to 120" );
- Fuses of protection suppli card and battery ;
- Output with cable holder;
- Alarm sounder 90 dB 12Vcc ;
- Internal sealed battery 12Vcc 1,2Ah ;
- Alarm output in free contact terminal board 250V~ 10A ;
- Flashing red lamp alarm 3W 12Vcc ( only in model ALARM 2 ) ;
- Box in thermoplastic material;
- Protection IP55;

**Do not use the product in environments where dust, acids, corrosive and/or flammable gases etc. are present.**

## 5. OPERATION



**DANGER**  
**RISK OF ELECTRIC**  
**SHOCK**



**DANGER**



**WARNING**

When the panel is on, the green led  **"Power supply"** is lightened to indicate the correct operation of the unit.

In absence of external alarm at the N.A. or N.C. input the acoustic and flashing alarm do not activate ( for the model ALARM 2 ) and only the green led  **"Power Supply"** is on if the panel is connected to the net ( 230V~ );

In this condition the internal buffer battery is kept automatically in charge in order to keep it always efficient;

It is possible ( AND ADVISABLE ), to test periodically the correct operation of the unit,

by pushing the button  **"TEST"**; the acoustic and flashing alarm (in the model ALARM 2) automatically activates until the release of the button.

When one of the two inlet N.O. or N.C. change their state (contact N.O. gets closet or contact N.C. gets opened) ALARM activates the acoustic and flashing alarm (in the model ALARM 2) which remains active on the base of the settings (see chapter "REGULATION AND CALIBRATION").

It is possible to set ALARM to stop sounding at the end of the alarm condition (inlet N.O. and N.C. go back to their normal condition) or to remain active even if the condition of alarm is not present anymore until the manual intervention of the

operator who can decide wether restore the normal operation pushing  **RESET"**

or interrupting only the sounding by pushing  **SIREN EXCLUSION"** (the red led 

**"SIREN OFF"** lights on); in this case the red led  **"ALARM"** remains lighted to signal that the anomaly is not solved yet;

It is even possible to activate an internal timer adjustable with potentiometer (from 25" to 120" ) for the delayed and automatic switching off of the sounder;

### FUSES REPLACEMENT

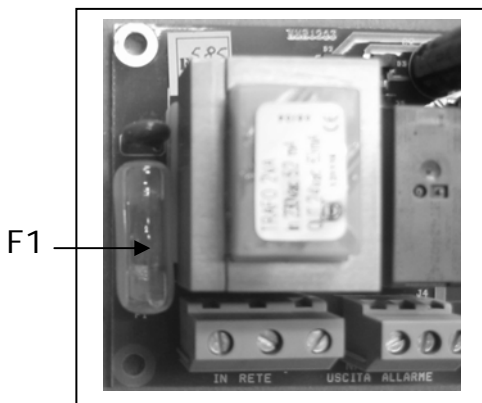

NET PROTECTION FUSE

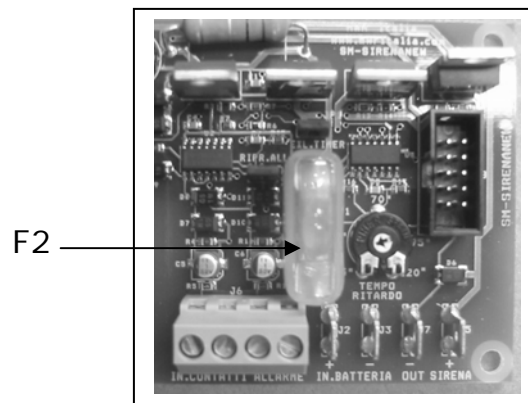

BATTERY PROTECTION FUSE

## 6. INSTALLATION



**DANGER**  
**RISK OF ELECTRIC**  
**SHOCK**



**DANGER**



**WARNING**

### Electrical connection

- For the electrical connection of ALARM INLET, POWER SUPPLY INLET and ALARM OUTPUT of the panel refer to the drawings.
- Connect the FASTON to the POSITIVE pole of the internal buffer battery;
- Connect the cable for power supply directly to the terminal of the electronic board (L – N – GROUND) making sure that the power supply is suitable for the panel ( 1 ~ 50/60Hz 230V  $\pm$  10%) .
- TO FIX THE CABLES ON THE TERMINAL USE THE TOOL OF THE PROPER SIZE TO AVOID TO DAMAGE THE SCREWS OR THEIR SEAT (If use an electric screwier pay attention not to spoil the thread or the screws.)
- FIX THE CONTROL PANEL TO A WALL AS IN PICTURE N.1 WITH SCREWS AND SCREW ANCHOR USING THE HOLES ARRANGED IN THE BOX OR THE FIXING BRACKET IF PRESENT.
- AFTER THE FIXING, REMOVE EVERY PLASTIC OR METALLIC SURPLUS INSIDE THE BOX (ex. Pieces of copper of the cables or plastic shavings of the box) BEFORE SUPPLING POWER.

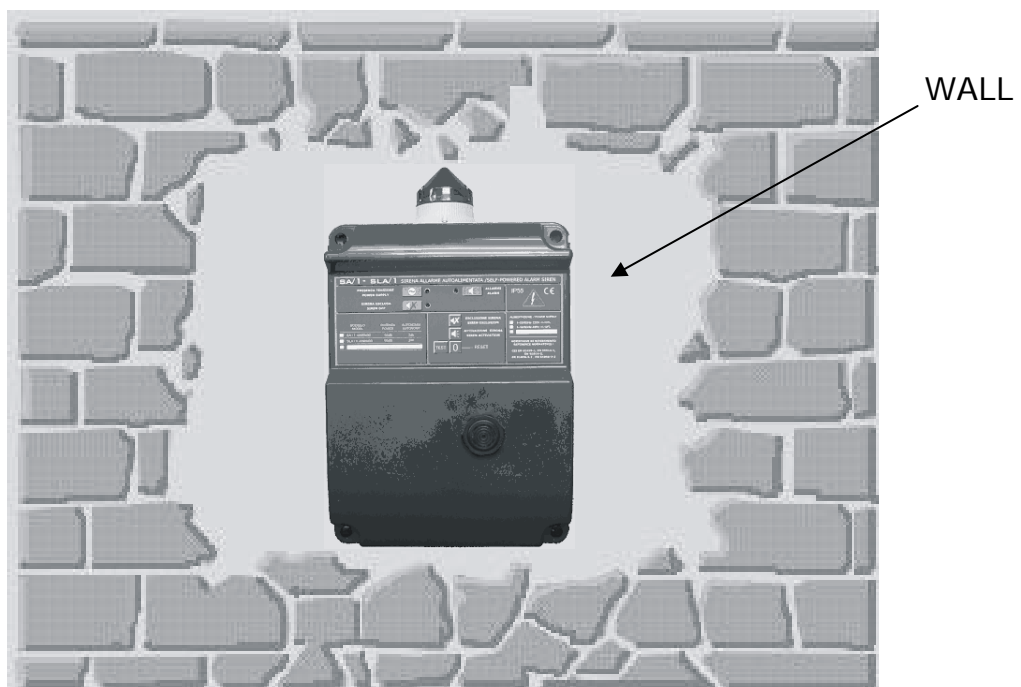

**Fig.1**

## 7. ELECTRICAL CONNECTION



**DANGER**  
**RISK OF ELECTRIC**  
**SHOCK**



**DANGER**



**WARNING**

### Power supply line

Connect the unit at ground before making any other connection.

Make sure that the supply voltage corresponds to the voltage indicated on the electric panel rating plates.

(1~230V+/- 10% 50/60Hz **SINGLE-PHASE**).

Cables, when visible, must be suitable protected.

The power line must be protected by a differential magnetotermic switch measured in accordance with the regulations locally in force.

### Connections on the electric panel.

Connect the unit at ground before making any other connection, by inserting the ground conductor in the terminal (PE).

Connect the power supply cable to the terminal board respecting L – line, N – neutral, and GROUND .

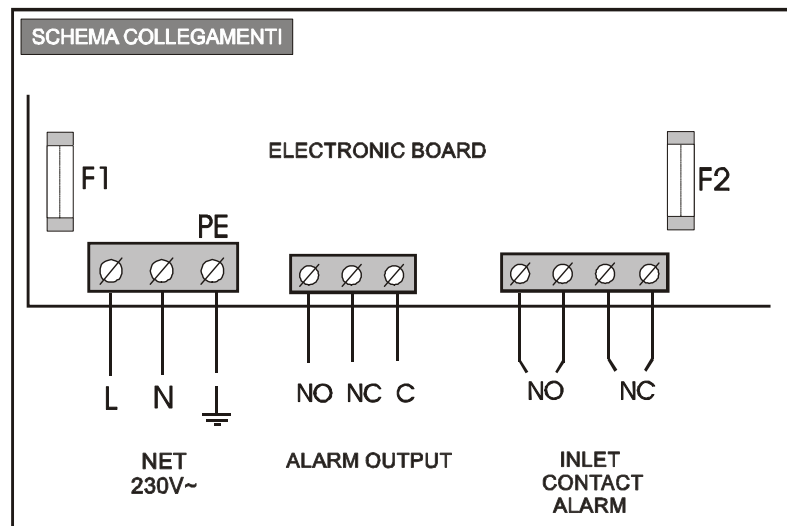

The inlet for alarm contacts only accept free contact, that is tensionless, like for example float switches.



## 8. REGULATION AND CALIBRATION

Select the kind of working before switching the panel on:

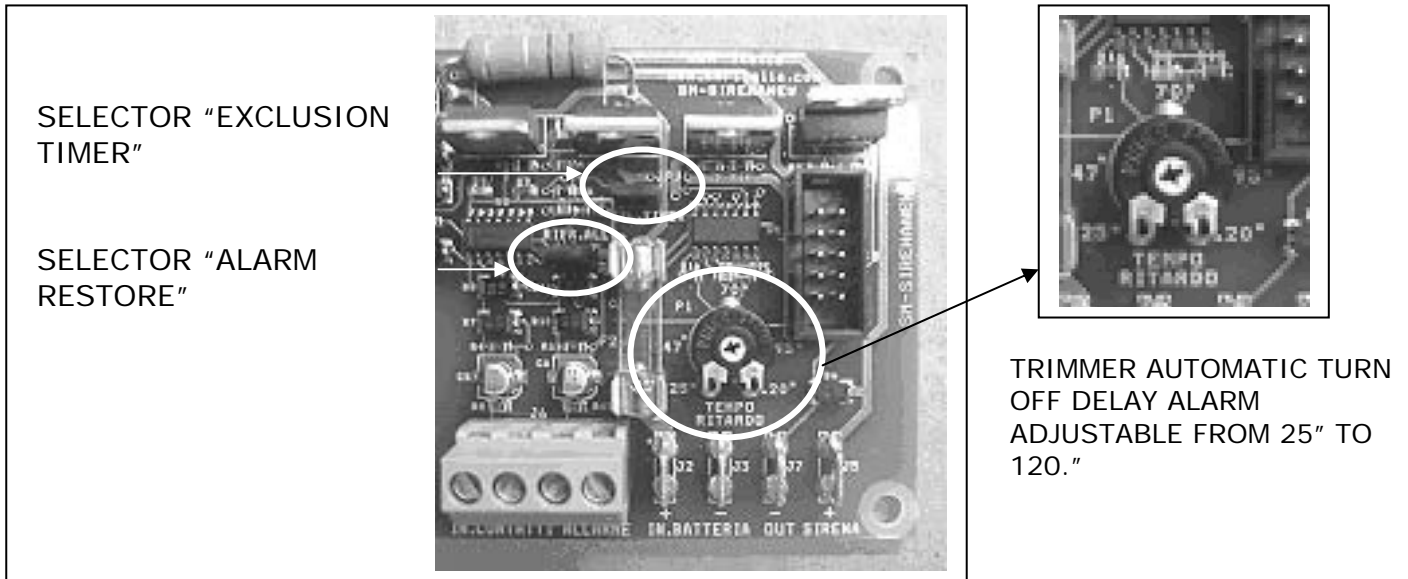



1. If the selector "exclusion timer" is put on, the timer is excluded and the acoustic alarm keeps-on sounding till the automatic or manual restore (depending on how the selector 2 is set);

With the selector disconnected the timer is active and, in case of alarm, it starts counting the seconds set with the regulation trimmer (25" – 120"). At the end of the seconds it switches the sounder off

2. With the selector "alarm restore" on, when the alarm stops there is the automatic restore; with the selector disconnected the restore is only possible by switching the button  " RESET ";

In any condition it is possible to exclude the sounder by switching the button

 "SIREN EXCLUSION " ( visible with the red led  " SIREN OFF ");

To restore the sounder it is necessary to switch on the button  "SIREN ACTIVATION" ( the red led "SIREN EXCLUDED" switches off ) ;

**N.B. : THE MODEL ALARM 2 IS SUPPLIED WITH FLASHING RED LIGHT WHICH ACTIVATES ALWAYS TOGETHER WITH THE SOUNDER !!**

## 9. LIGHTS



INDICATES THE PRESENCE OF THE CURRENT (**GREEN LIGHT**).



INDICATES THAT THE SOUNDER IS EXCLUDED (**RED LIGHT**).



INDICATES THAT THE ALARM IS ACTIVE (**RED LIGHT**).

## 10. MAINTENANCE



**DANGER**  
RISK OF ELECTRIC  
SHOCK



**DANGER**



**WARNING**

ALARM does not require any ordinary maintenance if used within the use limits. Eventual operation of maintenance have to be executed by expert and qualified personnel respecting the accident prevention measures.

### **DANGER!**

**Make sure the panel is disconnected from the power supply before performing any maintenance operations.**

## 11. WASTE DISPOSAL

After the control panel has been installed and started, the customer must provide for the appropriate elimination/disposal of the waste materials according to the legislation locally in force.

If the control panel or parts of it must be taken out of service and dismantled, follow local regulations regarding sorted waste disposal. Refer to the appropriate recycling centres.

**CAUTION:** Contamination of the environment with hazardous substances such as battery acid, fuel, oil, plastic, copper, etc., may cause serious damage to the environment and endanger people's health.

## 12. WARRANTY

Our products are guaranteed for a year from the date of commissioning; this applies only to products purchased from our offices or from our authorised retailers. The warranty does not extend beyond 15 months from the date of shipping. If the shipping documentation is missing, the date of manufacture is given in the code on the nameplate or fused into the interior of the terminal box. The warranty covers all manufacturing defects of material manufactured by us; it covers replacement and repair only, at our premises and by our staff, of the defective panel or part. The warranty does not provide for any claims by the customer. The warranty does not cover damage caused by faulty electrical connections, lack of adequate protection, incorrect assembly, incorrect use or any negligence in installing and operating the plant. The WARRANTY is also void in the following circumstances:

- damage due to corrosion or abrasion of any type or nature;
- malfunction due to improper installation;
- repair, disassembly or tampering by unauthorised persons;
- failure by the customer to pay due amounts.

The defective product must be returned to our factory carriage paid. We reserve the sole right to determine the cause of the defect and whether it is covered by the warranty or not. After the repair, the goods will be returned to the Customer carriage forward. WE DECLINE all liability for damages and injury caused by our products.

Fourgroup S.r.l. reserves the right to modify its products without notifications. Any controversy arising from the terms of this warranty shall be resolved in the Padua Court, even if payment is agreed by bank's draft.

For any further information, refer to the sales contract.

## 13. SPARE PARTS

Always state the exact model identification number and construction number when requesting technical information or spare parts from our sales and service centre.



Use only original spare parts when replacing any faulty components.



The use of unsuitable spare parts can cause malfunctions, personal injury and damage to property.

## 14. CONFORMITY DECLARATION

FOURGROUP S.r.l. with centre in Polverara – Padova – Italy, declare that the products

### **ALARM1 – ALARM2**

are in compliance with the following European directives and with the national directives of actuation :

- Machine 2006/42/CE
- European Directive 2006/95/CE
- Electromagnetic compatibility 2004/108/CE  
and following changes in compliance with the following technical rules:
- EN 60439-1, EN 55014-1, EN 55014-2, EN 61000-3-2, EN 61000-3-3

Polverara – Italy, 13/01/2010

TECHNICAL MANAGER

(Grigoletto Per. Ind. Walter)

