

# US 73 EX- US 103 EX

SUBMERSIBLE DRAINAGE PUMPS WITH EXPLOSION-PROOF



- Stationary use
- 30 mm free passage
- Controllable oil chamber
- SiC mechanical seal
- independent of sense of rotation
- Replaceable moisture sealed cable inlet

## DESCRIPTION

These robust centrifugal submersible drainage pumps US 73 Ex and US 103 Ex can be used for the handling of contaminated water containing fibres and particles up to 30 mm size (no stones). The pumps are suitable for mounting in collection chambers and pits located in hazardous areas. Hazardous areas are usually designated where the drainage system is fed from areas with vehicles, car parks, garages, tank farms or laboratories, etc.

Type of protection II 2 G Ex d IIB T4

The light weight of the pumps and low power consumption make the unit ideal for dealing with contaminated liquids in an economic manner.

This range of pumps is suitable for stationary use. For easy removal of the pumps from deep sumps we recommend the use of our guide rail systems GR 40 which provide ease of maintenance and inspection. A controllable oil chamber and wear-resistant special mechanical seal ensure a long service life. For automatic monitoring of the oil chamber a seal leak control can be connected.

According to Ex-proof testing regulations, these pumps are provided with winding thermostats and can only be used with the equivalent control unit (see accessories).

## PERFORMANCE

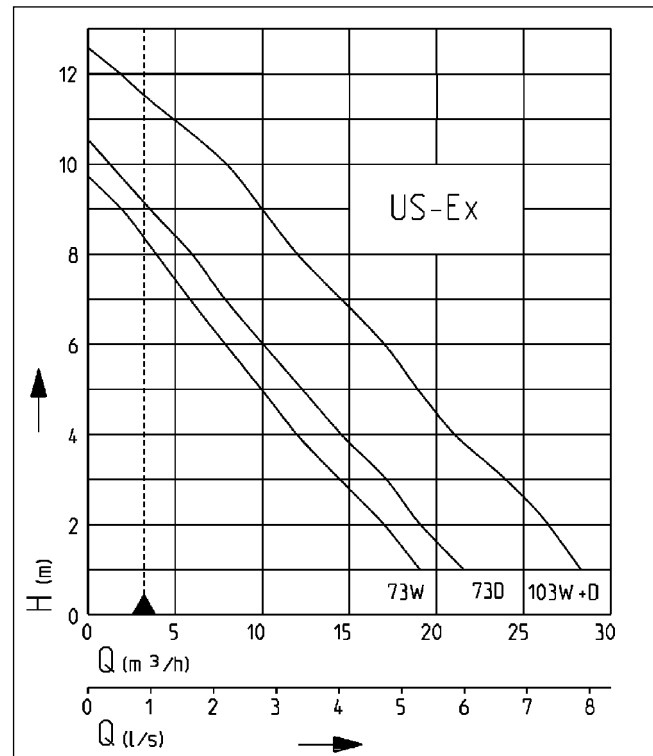

Type	Delivery head H [m]	1	2	3	4	5	6	7	8	9	10	12
US 73 E Ex	Flow rate Q [m³/h]	19	17	15	12	10	8	6	4	2		
US 73 D Ex		22	20	17	15	12	10	8	6	4		
US 103 E/D Ex		28	26	23	21	19	17	15	12	10	8	2

We reserve the right to change specifications without notice. Pump performance is subject to ISO 9906 tolerances

The minimum flow velocity in the pressure piping must be 0.7 m/s according to EN 12056. This data is represented in the performance curve as a limit of application.



# US 73 EX- US 103 EX

SUBMERSIBLE DRAINAGE PUMPS WITH EXPLOSION-PROOF

## SCOPE OF SUPPLY

Pump according to EN 12050 ready for connection with 10 m cable.

## MECHANICAL DATA

Pump	Vertical single-stage	Seal on medium side	SiC mechanical seal
Ex-proof	With ex-proof	Run dry protection	Yes
Free passage	30 mm	Shaft	Stainless steel
Bearing	Ball bearings, grease-lubricated	Impeller	Vortex impeller, GFK
Seal on motor side	Duplex rotary shaft seals	Motor housing	Grey cast iron
Oil chamber	Yes	Submersible	Yes
		Pressure outlet	IG 1 1/2"

## ELECTRICAL DATA

Power line	10m H07RN-F	Insulation class	F
Wires	6G1,5	Winding thermostat	Yes
Type of enclosure	IP 68	Plug	Without

## US 73 EX- US 103 EX

Type	Code No.	Voltage	Motor rating		Current	Weight
			P1	P2		
US 73 E Ex	JP09292	1/N/PE~230 V	0.83 kW	0.50 kW	3.9 A	19.0 kg
US 73 D Ex	JP00595	3/PE~400 V	0.85 kW	0.60 kW	1.4 A	19.0 kg
US 103 E Ex	JP09294	1/N/PE~230 V	1.37 kW	0.98 kW	6.0 A	21.5 kg
US 103 D Ex	JP09293	3/PE~400 V	1.36 kW	1.06 kW	2.4 A	21.5 kg

## Dimensions US 73 Ex and US 103 Ex (mm)

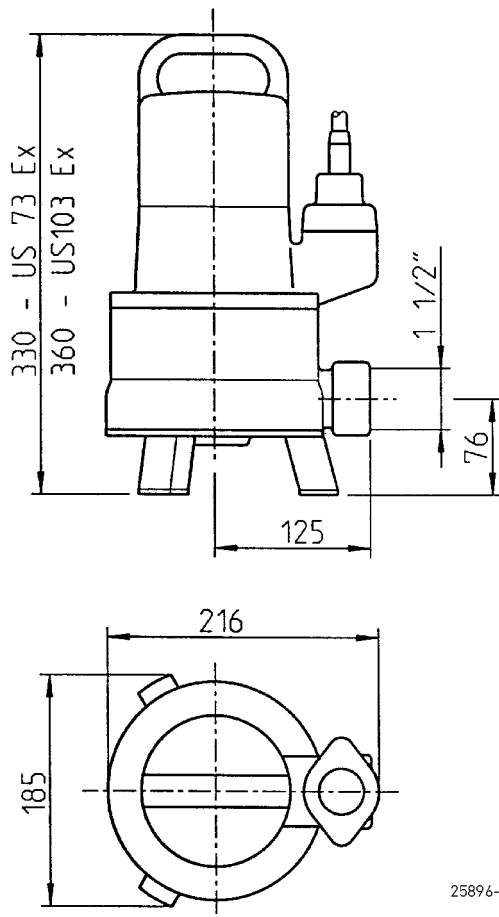

25896-02

## Dimensions with GR 40 (mm)

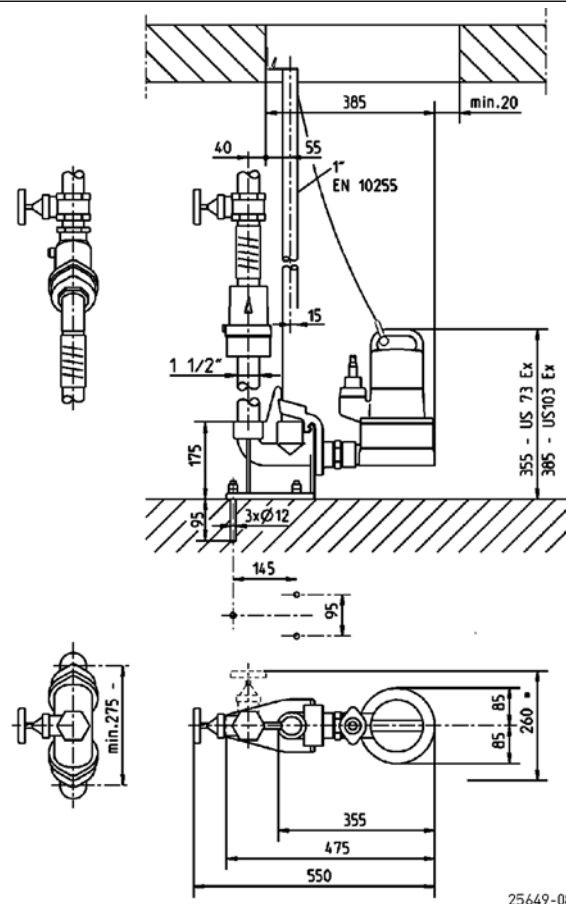

25649-08

# US 73 EX- US 103 EX

SUBMERSIBLE DRAINAGE PUMPS WITH EXPLOSION-PROOF

Example of single pump installation with GR

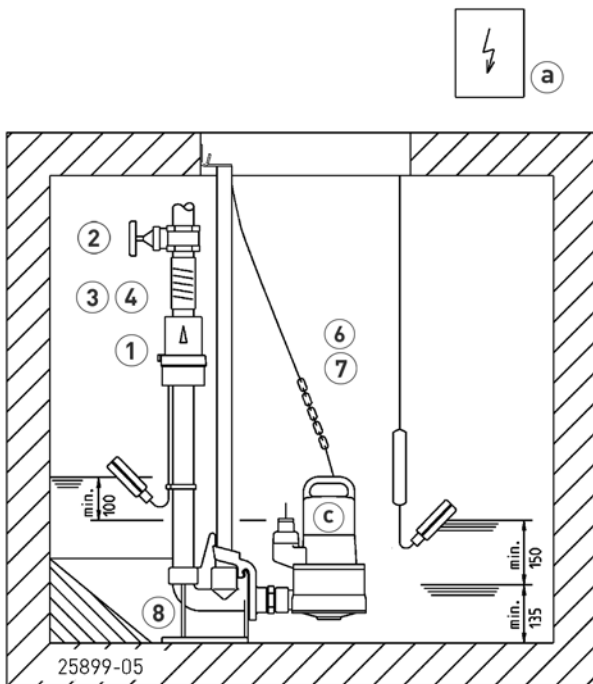

Example of duplex pump installation

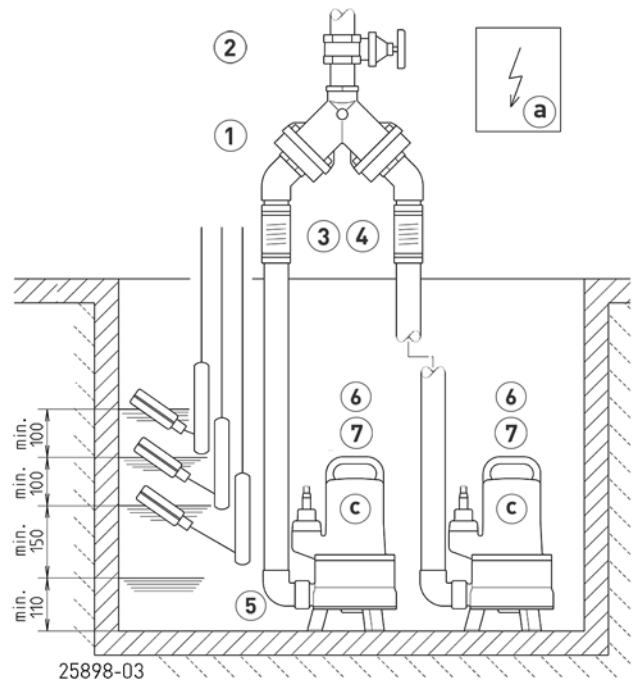

Single unit 1½" with GR 40: sump area min. 40x60 cm

Single unit 1½" without GR: sump area min. 40x40 cm

Duplex unit 1½" with GR 40: sump area min. 60x60 cm

Duplex unit 1½" without GR: sump area min. 40x60 cm









In case of installation beneath the backpressure level the pressure tube must be taken in a

loop over the local backup level acc. to EN 12056. Besides, it must be secured with an EN 12050-4-proofed swing-type check valve. Additionally we recommend an alarm system.

In accordance with EN 12056-4 section 5.1, it has a built-in automatic spare pump or a double attachment included, which ensures that sewage drainage is not interrupted.

Suspend control unit in a dry room

## MECHANICAL ACCESSORY

				Code No.
	<b>① Swing-type check valve</b>			
	R40 EN 12050-4	1½" (DN 40), PN 4	150x120 (HxB)	JP00317
	DR 40 EN 12050-4	1½" (DN 40), PN 4	200x280 (HxB)	JP09155
	<b>Ball-type check valve</b>			
	KE40 EN 12050-4	1½" (DN 40), PN 6	170x125 (HxB)	JP47974
	<b>② Stop valve</b>	brass, 1½" (DN 40), PN 16	125x60 (HxB)	JP44786
	<b>③ Elastic connection</b>	1½" (DN 40), PN 4	120x50 (HxD)	JP44777
	<b>④ Hose band clamp</b>	1½"		JP44763
	<b>⑤ Elbow</b>	1½"		JP45953
	<b>⑥ Chain</b>	certified, 2,5 m, 320 kg, 5 rings (EN 818 mod.) certified, 5,0 m, 320 kg, 8 rings (EN 818 mod.)		JP45901 JP45902
	<b>⑦ Webbing</b>	with shackle		JP45168

# US 73 EX- US 103 EX

SUBMERSIBLE DRAINAGE PUMPS WITH EXPLOSION-PROOF

## MECHANICAL ACCESSORY

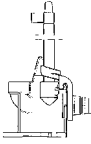
			Code No.
	<b>8 Guide rail system</b>	GR 40	JP25592
	Guide rail 1"	1500 mm	JP48937
	Guide rail 1"	2000 mm	JP48938
	Guide rail 1"	2500 mm	JP48939
	Guide rail 1"	3000 mm	JP48940

## ELECTRICAL ACCESSORY

			Code No.
	<b>a Control for single units</b>		
	Control unit AD 4 XE	for US 73E EX	JP25901
	Control unit AD 8 XE	for US 103E E	JP25902
	Control unit AD 23 X	for US 73D EX	JP09754
	Control unit AD 25 X	for US 103D EX	JP09683
	<b>Control for duplex units</b>		
	Control unit BD 23 X	for US 73 D EX	JP09755
	Control unit BD 25 X	for US 103 D EX	JP09681
	<b>Level control</b>		
	Subm. switch pack AmG		JP16719
Subm. switch pack BmG	3 subm. ball contact switch with 9.5 m and counterweight	JP16726	
Auxiliary switch unit ExH-A for explosion-proof pumps only		JP16720	
Auxiliary switch unit ExH-B for explosion-proof pumps only		JP00295	
<b>b Level control</b>			
Dry run protection		JP44603	
<b>c Seal leak detector</b>	DKG Ex for explosion-proof pumps	JP00249	